

akustiksan®

AKUSTIKSANWOOD

Wooden Panel Acoustical Systems



TURKISH ACOUSTIC

TURCOWOOD

Wooden Panel Acoustical Systems

For world-class sound absorption & reverberation control, Turkish Turcwood Wooden panels offer the best solution. These panels are a wide range of perforated, grooved wooden wall & ceiling panels. These are available in a standard range of veneers and laminate surfaces. Their design is durable and offer invisible interlocking and concealed fixing systems to ensure a seamless fit.

FEATURES

- Excellent Sound Absorption & Reverberation Control
- Fire Rated & Low Formaldehyde
- High Impact & Durable
- Black Felt Backing
- Invisible Interlocking & Concealed Fixing System

FIXING DETAILS

Linear Grooved Panels

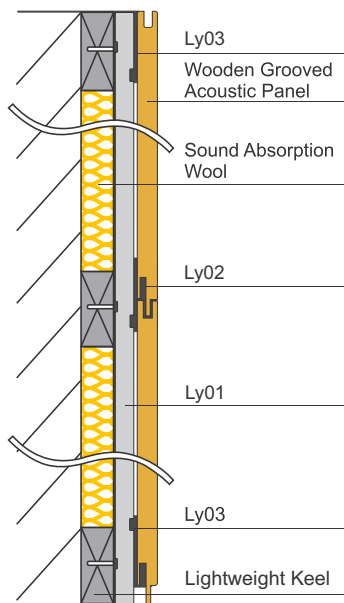

Cross-section Structure

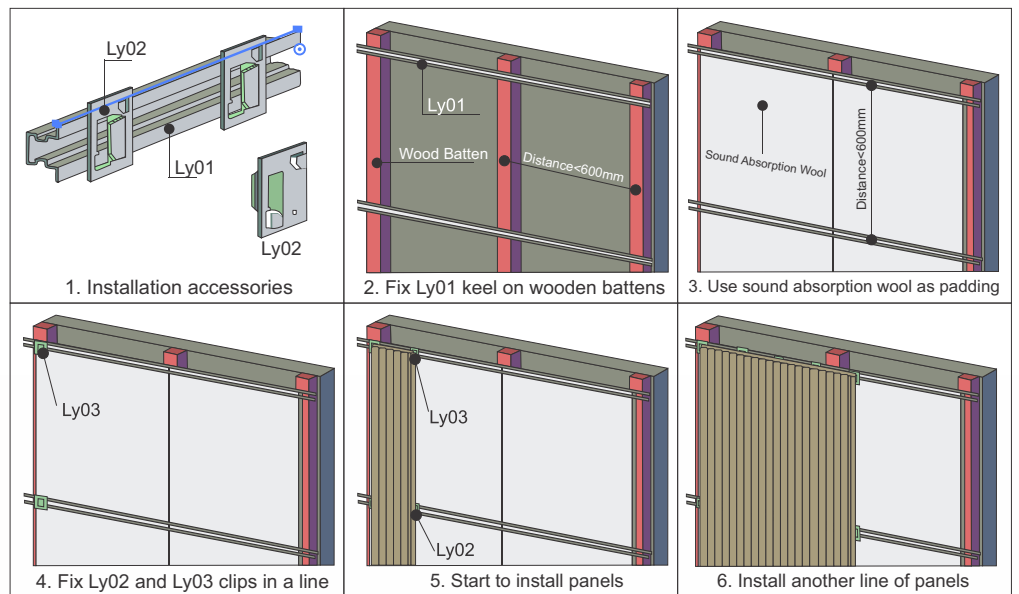

Installation: Lightweight Steel Keel System

Perforated Tiles

Installation System I (with gap)

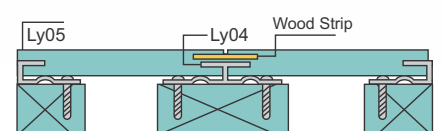

Cross-section Structure

Installation System II (without gap)

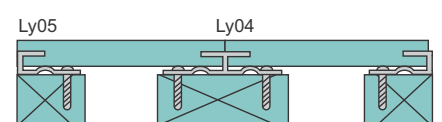

Cross-section Structure

ABSORPTION COEFFICIENT



Absorption Coefficient

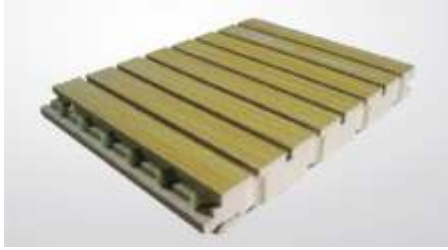

Pattern 13-3

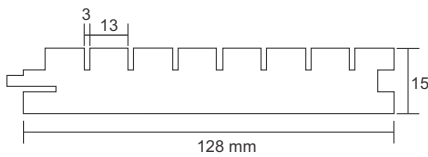

(Pattern 13-12) Perforation Rate:12%

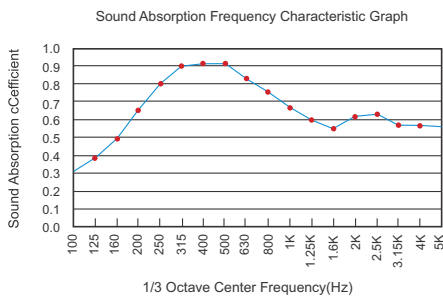

Pattern 14-2

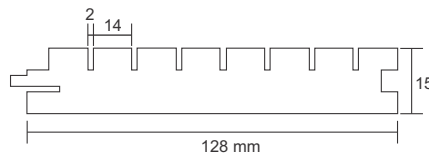

(Pattern 14-2) Perforation Rate:7.5%

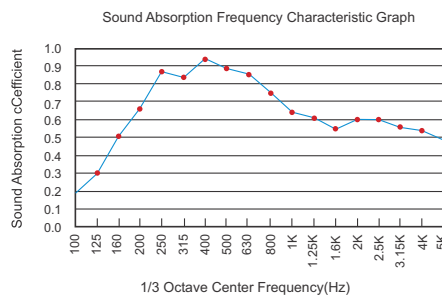

Pattern 28-4

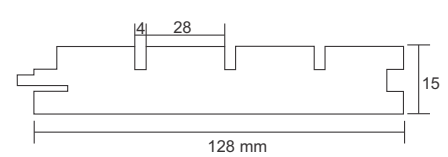

(Pattern 28-4) Perforation Rate:7%

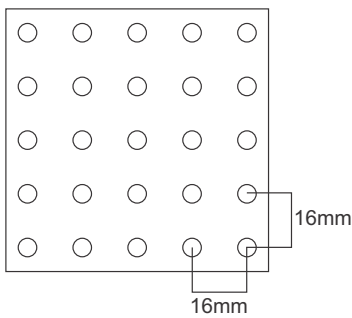
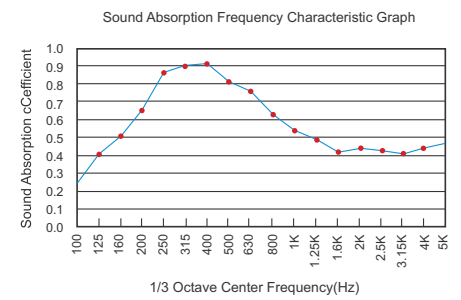

Pattern:16-16-6

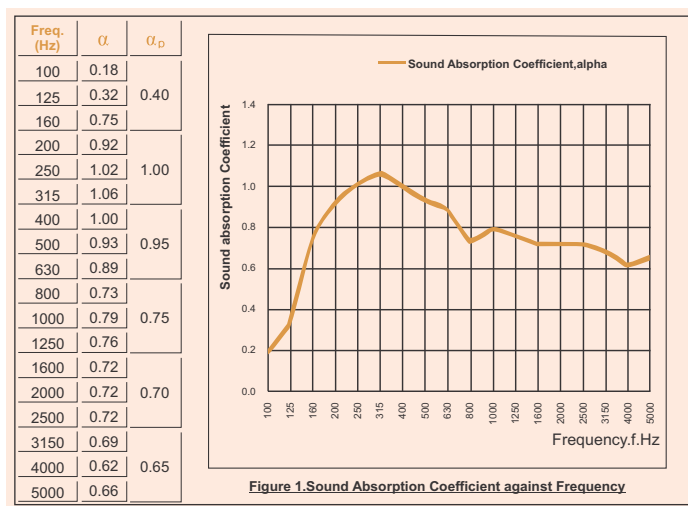
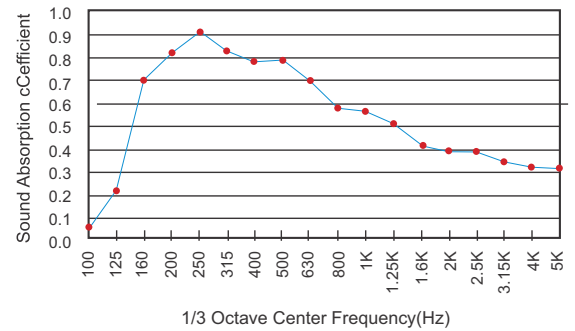

Linear Groove 13-3: NRC of 0.86 with Acoustic backing & Gap of 100mm.

AKUSTIKSANWOOD *Wooden Panel Acoustical Systems*

APPLICATIONS



COLOR PATTERNS



*TREW 006 Elegant
Walnut*



*TREW 007 Oak
White*



*TREW 011 Light
Cherry*

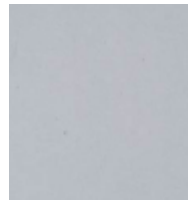

*TREW 012 Frosty
Grey*

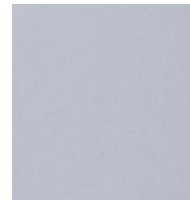

*TREW 014 Arctic
White*



*TREW 015 Bliss
Walnut*



*TREW 019 Tuscany
Walnut*



TREW 020 Maple



*TREW 025 Brazilian
Cherry*

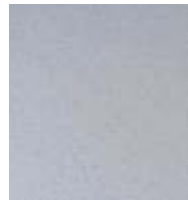

*TREW 026 Silver
Grey*



TREW 027 Cognac

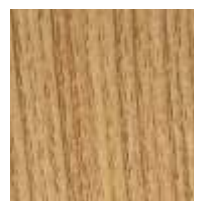

*TREW 028 Portland
Oak*



*TREW 035 Dark
Brazilian Cherry*



*TREW 042 Plateau
Teak*



TREW 043 Merbau



TREW 045 Dark Oak



*TREW 046 Atlas
Cherry*



TREW 048 Beech



*TREW 052 Borneo
Teak*

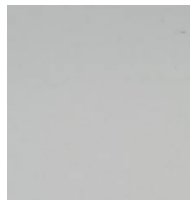

*TREW 101 Bright
White*

DESIGN PATTERNS

CUSTOM DESIGNS



CS 1001



CS 1002



CS 1003



CS 1004



CS 1005



CS 1006



CS 1007



CS 1008



CS 1009



CS 1010



CS 1011



CS 1012



CS 1013



CS 10014



S56D Slots



S56 Slots



S32 Square



SI100 Slots Offset

PERFORATED



P616D Holes

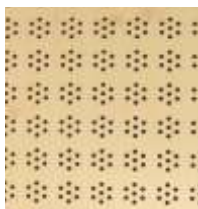

Pf3 Holes



P616 Holes



P416 Holes



P816 Holes



P932 Holes



Pf1 Holes



P316 Holes



Pf05

DIFFUSERS



1D Diffuser



2D Diffuser



3D Pyramid Diffuser



Diffuser 36



Diffuser 101



Diffuser 104



Diffuser-J10



Diffuser 6020



Diffuser-DF-30



Diffuser 105



Diffuser 106



Diffuser-6T



Pyramid



Radius

LINEAR



Grooves 168



Grooves 324



Grooves 816



AKUSTİKSAN

Adil Mah. Pelit Sk. 66 İstanbul/Sultanbeyli 34920

P: +90 (216) 592 50 66 M: +90 532 452 26 74

E: destek@akustiksan.com.tr

www.akustiksan.com.tr